

G12 Series

large basic Limit Switch



■ Features

- Housing are Made of High Temperature Bake Lite
- Precise Operation Repeatability
- Long Mechanical Life
- ENEC/UL/CUL/CQC Approved

■ Application

- Machine Tools
- Elevators
- Auto Production Line
- Civilian, Industrial Machinery Field
- Any Automation Applications in Automative Field

■ Parameters:

Rating	16A	ENEC/CQC 16A 125/250 or 480VAC 1/8HP 125VAC 1/4HP 250VAC 0.5A 125VDC 0.25A 250VDC
		UL/cUL 16A 125/250VAC 5E4 μ 40T85
	22A	ENEC/CQC 22A 125/250 or 480VAC 1/4HP 125VAC 1/2HP 250VAC 0.5A 125VDC 0.25A 250VDC
		UL/cUL 22A 125/250VAC 5E4 μ 40T85
	26A	ENEC/CQC 26A 125/250 or 480VAC 1/4HP 125VAC 1/2HP 250VAC 0.5A 125VDC 0.25A 250VDC
		UL/cUL 26A 125/250VAC 5E4 μ 40T85
Operating Frequency	Electrical	10~30 cycles/min
	Mechanical	240 cycles/min
Contact Resistance(Initial Value)		50m Ω Max
Insulation Resistance(at500 VDC)		100M Ω Min(at500VDC)
Dielectric Strength	between terminals	1500VAC 50/60Hz 1min
	between terminals and housing	2500VAC 50/60Hz 1min
Storage Temperature		-40 $^{\circ}$ C ~+85 $^{\circ}$ C
Storage Humidity		85%RH Max
Service Life	Electrical	50,000 cyles or 100,000 cyles Depends on part No.
	Mechanical	10,000,000 cycles
Unit Net Weight		Approx60g(Drip proof panel mounting type)

G12Series Micro Switch Ordering Instruction

G12	16	I	R1	A	A	-	K	X
Switch Type	Electrical Life	Protection Type	Level Type	Circuit Code	Terminal Type	Special Designator	Special Designator	Special Designator
G12 Series Micro Switch	16 UL/CUL: 16A 125/250 or 480VAC 1/8HP 1.25VAC 1/4HP 250VAC 0.5A 1.25VDC ENEC/CQC: 16A 250VAC 5E4 μ 40T85	1 General Type	R1 Pin Plunger	A SPDT	A Screw Terminals	Mounting Hole		
	22 UL/CUL: 26A 125/250 or 480VAC 1/4HP 1.25VAC 1/2HP 250VAC 0.5A 1.25VDC ENEC: 0.25A 250VDC 22A 250VAC 5E4 μ 40T85	2 Ip62 IP14 Proof Type	RD1 Spring Pin Plunger	B SPST-NC	B Solder Terminals	K Mounting Hole		
	26 UL/CUL: 26A 125/250 or 480VAC 1/2HP 1.25VAC 1HP 250VAC 0.5A 1.25VDC ENEC: 0.25A 250VDC 26A 250VAC 5E4 μ 40T85	3 Ip63 IP17 Proof Type (Terminal Included)	RQ1 Panel Mounting Plunger	C SPST-NO	... Other	D Special for High DC Rating		
...	Other		RQ2 Panel Mounting roller			... Other		
			RQ3 Panel Mounting Cross Roller Plunger					
			RW1 Swing Lever					
			RW2 Short Swing Lever					
			RW3 Roller Swing Lever					
			RW4 Short Swing Lever					
			RL1 Spring Straight Lever					
			RL2 Spring Roller Lever					
			... Other					

Here means special designator letter, refer to product specification for details.

■ Mounting Hole Dimensions

(单位Unit:mm)

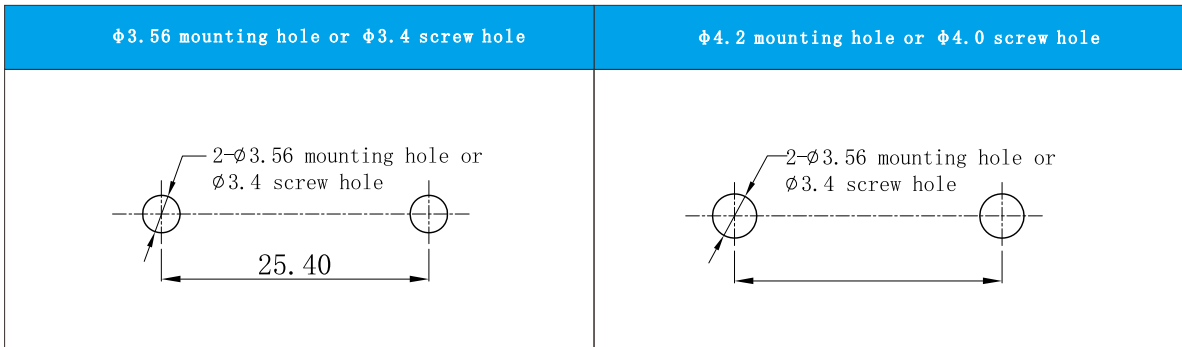

■ Circuit Configuration

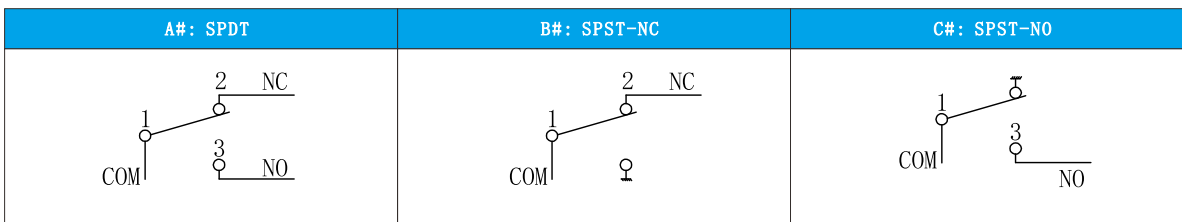

■ Terminal Type and Dimensions

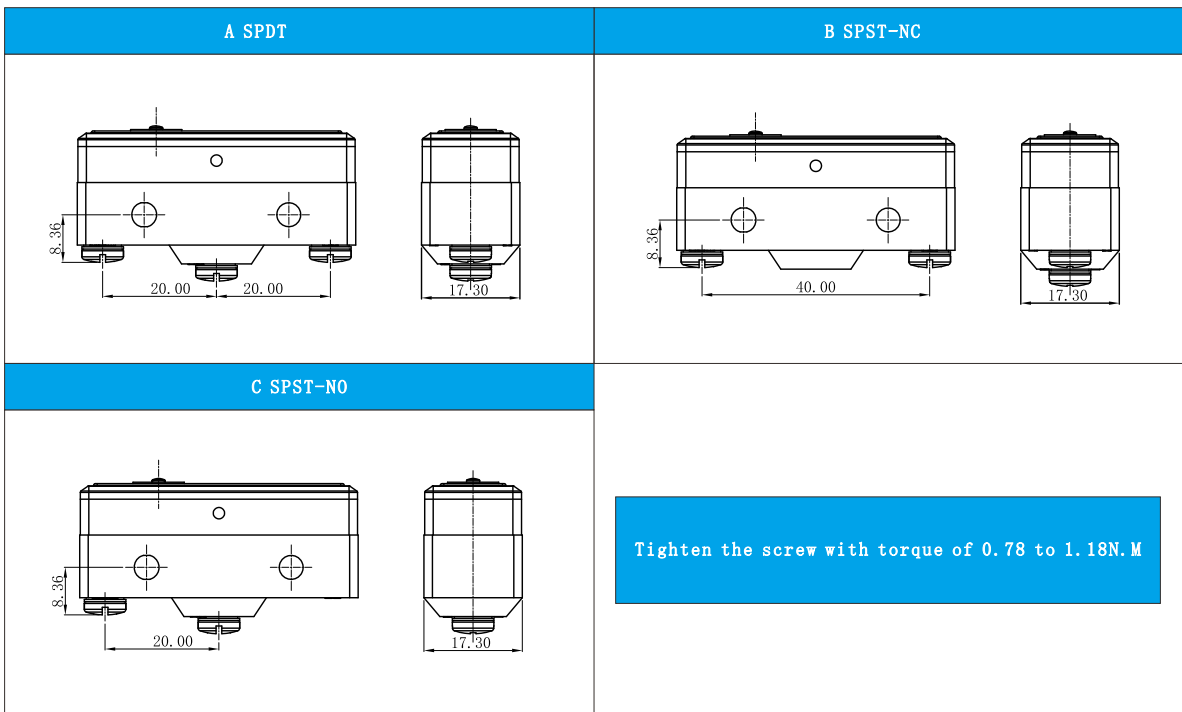

Dimensions and Operating Characteristics

◆G12□□-1R1□□-□

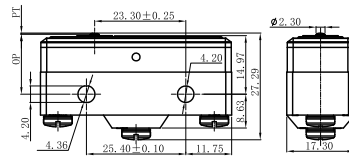

	OF Max. (gf)	RF Min. (gf)	PT Max. (mm)	OT Min. (mm)	MD Max. (mm)	FP Max. (mm)	OP (mm)
G1216	370	620	0.7	0.13	0.1	16.7	15.9±0.4
G1222							
G1226							

◆G12□□-1RD1□□-□

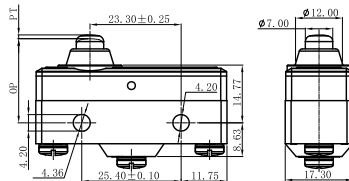

	OF Max. (gf)	RF Min. (gf)	PT Max. (mm)	OT Min. (mm)	MD Max. (mm)	FP Max. (mm)	OP (mm)
G1216	370	620	0.7	1.5	0.1	22.5	21.5±0.5
G1222							
G1226							

◆G12□□-1RQ1□□-□

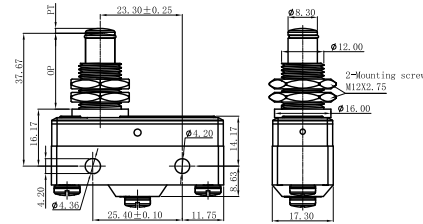

	OF Max. (gf)	RF Min. (gf)	PT Max. (mm)	OT Min. (mm)	MD Max. (mm)	FP Max. (mm)	OP (mm)
G1216	370	620	0.7	5.5	0.1	23	21.8±0.8
G1222							
G1226							

◆G12□□-1RQ2□□-□

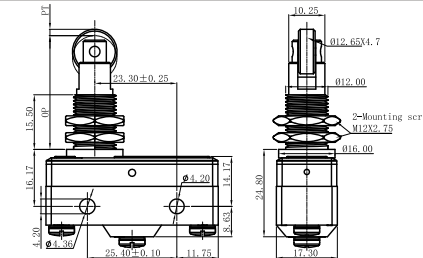

	OF Max. (gf)	RF Min. (gf)	PT Max. (mm)	OT Min. (mm)	MD Max. (mm)	FP Max. (mm)	OP (mm)
G1216	370	620	0.7	3.58	0.1	35	33.4±1.2
G1222							
G1226							

◆G12□□-1RQ3□□-□

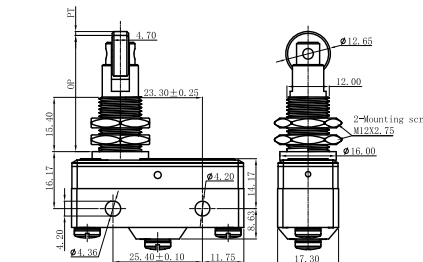

	OF Max. (gf)	RF Min. (gf)	PT Max. (mm)	OT Min. (mm)	MD Max. (mm)	FP Max. (mm)	OP (mm)
G1216	370	620	0.7	3.58	0.1	35	33.4±1.2
G1222							
G1226							

◆G12□□-1RW1□□-□

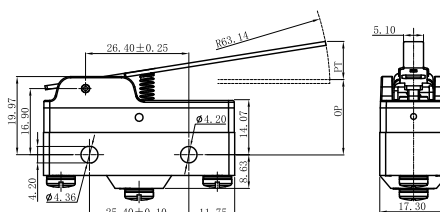

	OF Max. (gf)	RF Min. (gf)	PT Max. (mm)	OT Min. (mm)	MD Max. (mm)	FP Max. (mm)	OP (mm)
G1216	70	14	10.0	5.6	2	28.2	19.0±2.0
G1222							
G1226							

◆G12□□-1RW2□□-□

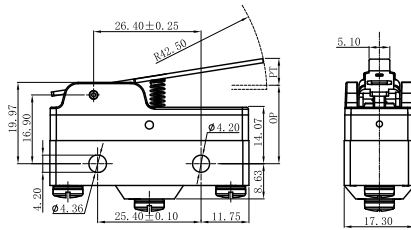

OF Max. (gf)	RF Min. (gf)	PT Max. (mm)	OT Min. (mm)	MD Max. (mm)	FP Max. (mm)	OP (mm)
G1216	105	20	6.6	3.7	0.85	24.5
G1222	180					
G1226						

◆G12□□-1RW3□□-□

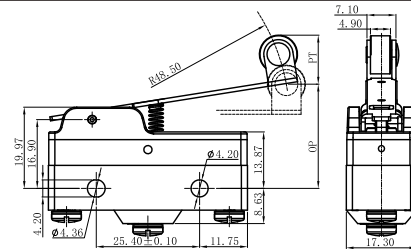

OF Max. (gf)	RF Min. (gf)	PT Max. (mm)	OT Min. (mm)	MD Max. (mm)	FP Max. (mm)	OP (mm)
G1216	100	20	7.1	4	1.02	36.5
G1222	170					
G1226						

◆G12□□-1RW4□□-□

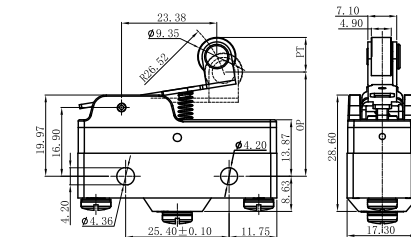

OF Max. (gf)	RF Min. (gf)	PT Max. (mm)	OT Min. (mm)	MD Max. (mm)	FP Max. (mm)	OP (mm)
G1216	160	40	2.7	2.4	0.8	32.5
G1222	270					
G1226						

◆G12□□-1RL1□□-□

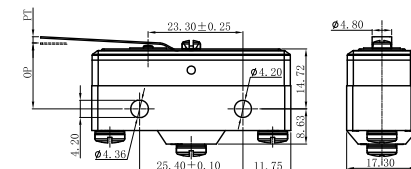

OF Max. (gf)	RF Min. (gf)	PT Max. (mm)	OT Min. (mm)	MD Max. (mm)	FP Max. (mm)	OP (mm)
G1216	140	14	4.0	1.6	1.3	20.6
G1222	230					
G1226						

◆G12□□-1RL2□□-□

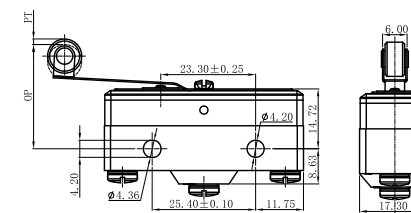

OF Max. (gf)	RF Min. (gf)	PT Max. (mm)	OT Min. (mm)	MD Max. (mm)	FP Max. (mm)	OP (mm)
G1216	150	14	4.0	1.6	1.3	31.8
G1222	250					
G1226						

◆G12□□-2R1□□-□

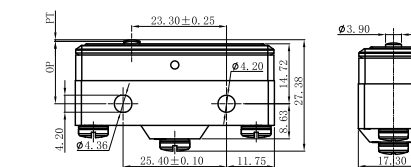

OF Max. (gf)	RF Min. (gf)	PT Max. (mm)	OT Min. (mm)	MD Max. (mm)	FP Max. (mm)	OP (mm)
G1216	430	115	0.7	0.13	0.06	16.5
G1226						

◆G12□□-2RL1□□-□

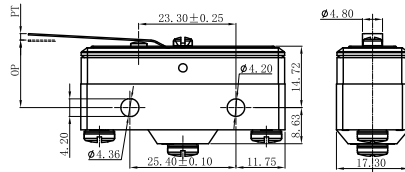

OF Max. (gf)	RF Min. (gf)	PT Max. (mm)	OT Min. (mm)	MD Max. (mm)	FP Max. (mm)	OP (mm)	
G1216	140	14	4.0	1.6	1.3	20.6	17.4±0.8

◆G12□□-2RL2□□-□

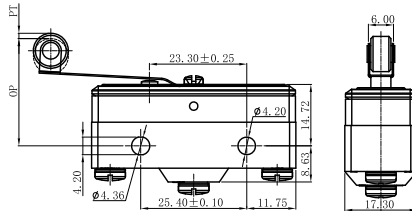

OF Max. (gf)	RF Min. (gf)	PT Max. (mm)	OT Min. (mm)	MD Max. (mm)	FP Max. (mm)	OP (mm)	
G1216	140	14	4.0	1.6	1.3	31.8	28.6±0.8

◆G12□□-2RQ1□□-□

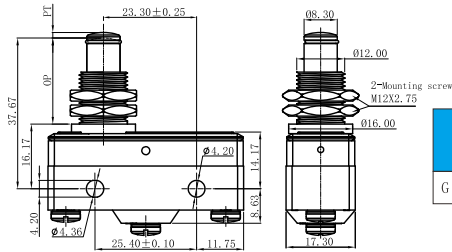

OF Max. (gf)	RF Min. (gf)	PT Max. (mm)	OT Min. (mm)	MD Max. (mm)	FP Max. (mm)	OP (mm)	
G1216	370	115	0.7	5.5	0.05	23	21.8±0.8

◆G12□□-2RQ2□□-□

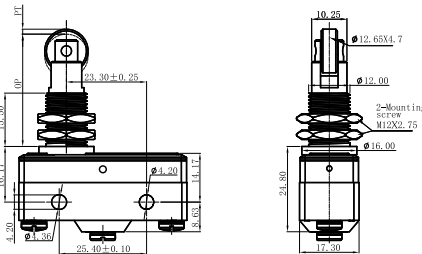

OF Max. (gf)	RF Min. (gf)	PT Max. (mm)	OT Min. (mm)	MD Max. (mm)	FP Max. (mm)	OP (mm)	
G1216	370	115	0.7	3.58	0.05	35	33.4±1.2

◆G12□□-2RQ3□□-□

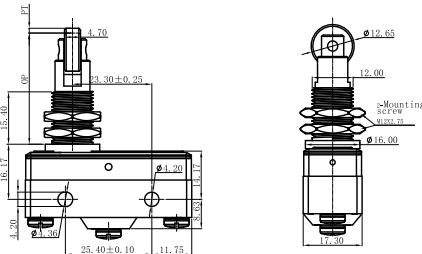

OF Max. (gf)	RF Min. (gf)	PT Max. (mm)	OT Min. (mm)	MD Max. (mm)	FP Max. (mm)	OP (mm)	
G1216	370	115	0.7	3.58	0.05	35	33.4±1.2

◆G12□□-3R1□□-□

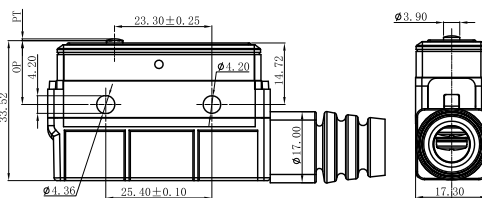

OF Max. (gf)	RF Min. (gf)	PT Max. (mm)	OT Min. (mm)	MD Max. (mm)	FP Max. (mm)	OP (mm)	
G1216	370	115	0.7	0.13	0.05	16.5	15.9±0.4

◆ G12□□-3RQ1□□-□

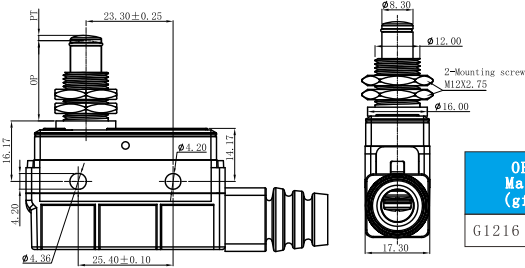

	OF Max. (gf)	RF Min. (gf)	PT Max. (mm)	OT Min. (mm)	MD Max. (mm)	FP Max. (mm)	OP (mm)
G1216	370	115	0.7	5.5	0.05	23	21.8±0.8

◆ G12□□-3RQ2□□-□

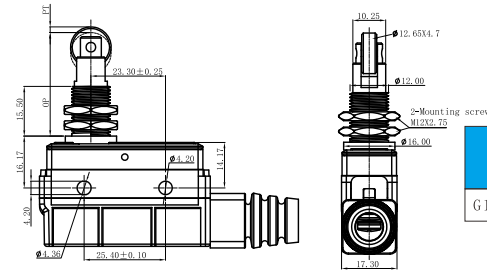

	OF Max. (gf)	RF Min. (gf)	PT Max. (mm)	OT Min. (mm)	MD Max. (mm)	FP Max. (mm)	OP (mm)
G1216	370	115	0.7	3.58	0.05	35	33.4±1.2

◆ G12□□-3RQ3□□-□

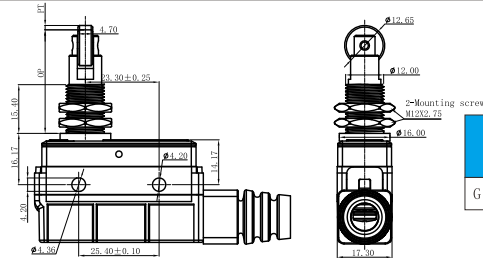

	OF Max. (gf)	RF Min. (gf)	PT Max. (mm)	OT Min. (mm)	MD Max. (mm)	FP Max. (mm)	OP (mm)
G1216	370	115	0.7	3.58	0.05	35	33.4±1.2

◆ G12□□-3RL1□□-□

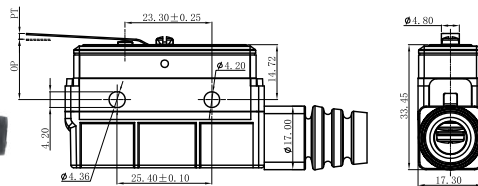

	OF Max. (gf)	RF Min. (gf)	PT Max. (mm)	OT Min. (mm)	MD Max. (mm)	FP Max. (mm)	OP (mm)
G1216	140	14	4.0	1.6	1.3	20.6	17.4±0.8

◆ G12□□-3RL2□□-□

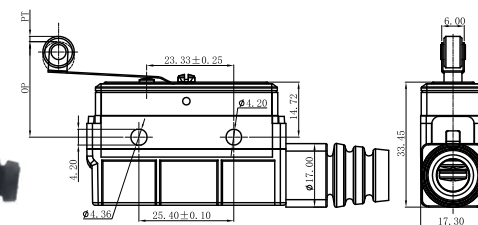

	OF Max. (gf)	RF Min. (gf)	PT Max. (mm)	OT Min. (mm)	MD Max. (mm)	FP Max. (mm)	OP (mm)
G1216	150	14	4.0	1.6	1.3	31.8	28.6±0.8